

PERFORMANCE
MADE
SMARTER

Product manual

4179

Universal AC / DC transmitter



TEMPERATURE | I.S. INTERFACES | COMMUNICATION INTERFACES | MULTIFUNCTIONAL | ISOLATION | DISPLAY

No. 4179V101-UK
Serial no.: 181752500-191027000



6 Product Pillars

to meet your every need

Individually outstanding, unrivalled in combination

With our innovative, patented technologies, we make signal conditioning smarter and simpler. Our portfolio is composed of six product areas, where we offer a wide range of analog and digital devices covering over a thousand applications in industrial and factory automation. All our products comply with or surpass the highest industry standards, ensuring reliability in even the harshest of environments and have a 5-year warranty for greater peace of mind.



Temperature

Our range of temperature transmitters and sensors provides the highest level of signal integrity from the measurement point to your control system. You can convert industrial process temperature signals to analog, bus or digital communications using a highly reliable point-to-point solution with a fast response time, automatic self-calibration, sensor error detection, low drift, and top EMC performance in any environment.



I.S. Interface

We deliver the safest signals by validating our products against the toughest safety standards. Through our commitment to innovation, we have made pioneering achievements in developing I.S. interfaces with SIL 2 Full Assessment that are both efficient and cost-effective. Our comprehensive range of analog and digital intrinsically safe isolation barriers offers multifunctional inputs and outputs, making PR an easy-to-implement site standard. Our backplanes further simplify large installations and provide seamless integration to standard DCS systems.



Communication

We provide inexpensive, easy-to-use, future-ready communication interfaces that can access your PR installed base of products. All the interfaces are detachable, have a built-in display for readout of process values and diagnostics, and can be configured via push-buttons. Product specific functionality includes communication via Modbus and Bluetooth and remote access using our PR Process Supervisor (PPS) application, available for iOS and Android.



Multifunction

Our unique range of single devices covering multiple applications is easily deployable as your site standard. Having one variant that applies to a broad range of applications can reduce your installation time and training, and greatly simplify spare parts management at your facilities. Our devices are designed for long-term signal accuracy, low power consumption, immunity to electrical noise and simple programming.



Isolation

Our compact, fast, high-quality 6 mm isolators are based on microprocessor technology to provide exceptional performance and EMC-immunity for dedicated applications at a very low total cost of ownership. They can be stacked both vertically and horizontally with no air gap separation between units required.



Display

Our display range is characterized by its flexibility and stability. The devices meet nearly every demand for display readout of process signals, and have universal input and power supply capabilities. They provide a real-time measurement of your process value no matter the industry, and are engineered to provide a user-friendly and reliable relay of information, even in demanding environments.

Universal AC / DC transmitter 4179

Table of contents

Warning	4
Symbol identification	4
Safety instructions	5
How to demount system 4000	6
Application	7
Technical characteristics	7
Mounting / installation / programming	7
Applications	8
PR 45xx display / programming front	9
Mounting / demounting the PR 45xx	9
Order	10
Accessories	10
Electrical specifications	10
Configurable input error indication and input limits	13
45xx display readout of input error detection and signal "outside range"	15
Connections	16
Block diagram	17
Configuration / operating the function keys	18
Routing diagram	20
Routing diagram, advanced settings (ADV.SET)	23
Help text overview	24
Document history	25

Warning



GENERAL

This device is designed for connection to hazardous electric voltages. Ignoring this warning can result in severe personal injury or mechanical damage.

To avoid the risk of electric shock and fire, the safety instructions of this guide must be observed and the guidelines followed. The specifications must not be exceeded, and the device must only be applied as described in the following.

Prior to the commissioning of the device, this installation guide must be examined carefully.

Only qualified personnel (technicians) should install this device. If the equipment is used in a manner not specified by the manufacturer, the protection provided by the equipment may be impaired.

Warning



**HAZARD-
OUS
VOLTAGE**

Until the device is fixed, do not connect hazardous voltages to the device. The following operations should only be carried out on a disconnected device and under ESD safe conditions:

General mounting, connection and disconnection of wires.

Troubleshooting the device.

Repair of the device and replacement of circuit breakers must be done by PR electronics A/S only.

Warning



CAUTION

Do not open the front plate of the device as this will cause damage to the connector for the display / programming front PR 45xx.

This device contains no DIP-switches or jumpers.

SYSTEM 4000 must be mounted on a DIN rail according to DIN EN 60715.

Symbol identification



Triangle with an exclamation mark: Warning /demand. Potentially lethal situations. Read the manual before installation and commissioning of the device in order to avoid incidents that could lead to personal injury or mechanical damage.



The CE mark proves the compliance of the device with the essential requirements of the directives.



The double insulation symbol shows that the device is protected by double or reinforced insulation.

Safety instructions

Definitions

Hazardous voltages have been defined as the ranges: 75 to 1500 Volt DC, and 50 to 1000 Volt AC.

Technicians are qualified persons educated or trained to mount, operate, and also trouble-shoot technically correct and in accordance with safety regulations.

Operators, being familiar with the contents of this manual, adjust and operate the knobs or potentiometers during normal operation.

Receipt and unpacking

Unpack the device without damaging it and check whether the device type corresponds to the one ordered. The packing should always follow the device until this has been permanently mounted.

Environment

Avoid direct sun light, dust, high temperatures, mechanical vibrations and shock, and rain and heavy moisture. If necessary, heating in excess of the stated limits for ambient temperatures should be avoided by way of ventilation.

The device must be installed in pollution degree 2 or better.

Mounting

Only technicians, who are familiar with the technical terms, warnings, and instructions in the manual and who are able to follow these, should connect the device. Should there be any doubt as to the correct handling of the device, please contact your local distributor or, alternatively,

PR electronics A/S
www.prelectronics.com

Mounting and connection of the device should comply with national legislation for mounting of electric materials, i.e. wire cross section, protective fuse, and location.

Descriptions of input / output and supply connections are shown in the block diagram and side label.

The following apply to fixed hazardous voltages-connected devices:

The max. size of the protective fuse is 10 A and, together with a power switch, it should be easily accessible and close to the device. The power switch should be marked with a label indicating that it will switch off the voltage to the device.

Year of manufacture can be taken from the first two digits in the serial number.

UL installation requirements

Use 60/75°C copper conductors only

For use only in pollution degree 2 or better

Max. ambient temperature 60°C

Max. wire size. AWG 26-14

UL file number E248256

Calibration and Adjustment

During calibration and adjustment, the measuring and connection of external voltages must be carried out according to the specifications of this manual. The technician must use tools and instruments that are safe to use.

Normal operation

Operators are only allowed to adjust and operate devices that are safely fixed in panels, etc., thus avoiding the danger of personal injury and damage. This means there is no electrical shock hazard, and the device is easily accessible.

Cleaning

When disconnected, the device may be cleaned with a cloth moistened with distilled water.

Liability

To the extent the instructions in this manual are not strictly observed, the customer cannot advance a demand against PR electronics A/S that would otherwise exist according to the concluded sales agreement.

How to demount system 4000

Picture 1:

The device is detached from the DIN rail by moving the bottom lock down.

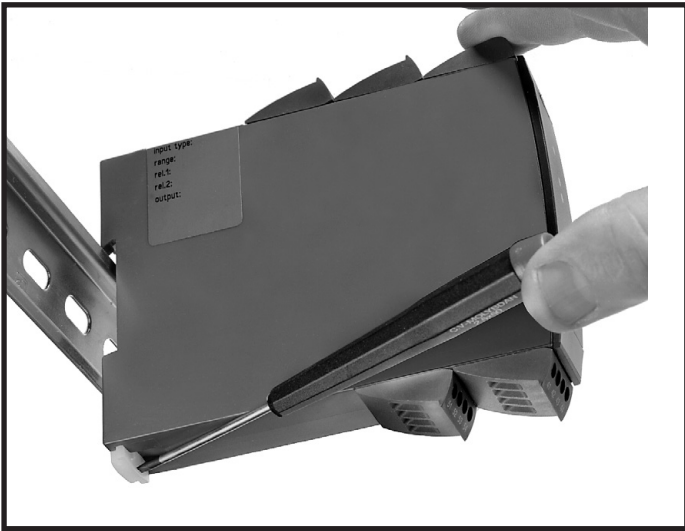

Universal AC/DC transmitter

4179

- Measures AC current and voltage signals and converts these into uni-/bipolar DC current and voltage signals
- Outputs passive or active current signals
- Programming, process monitoring and diagnostics via 45xx
- Response time < 0.75 s and excellent accuracy better than 0.3%
- Universally powered by 21.6...253 VAC / 19.2...300 VDC

Application

- The 0... 5 AAC range makes it possible to accurately measure a typical current transformer.
- The 0...300 VAC range allows accurate supply voltage monitoring.
- The 4179 measures standard input ranges, and can be freely configured to customer-defined input range.
- Converts narrow AC current / voltage inputs to wide bipolar or unipolar outputs, e.g. 0...1 VAC input = ± 10 volt or 4...20 mA output with a minimum span of 0.5 AAC or 0.5 VAC.
- The detachable 45xx displays provide enhanced diagnostics.
- Configurable input limits control the output value for increased safety.
- The 4179 is designed according to strict safety requirements and is thus suitable for application in SIL 2 installations.
- Suitable for the use in systems up to Performance Level "d" according to ISO-13849.

Technical characteristics

- The latest analog and digital techniques are used to obtain maximum accuracy and immunity to interference.
- Possibility of output safety readback by selecting S4...20 mA output.
- Response time < 0.75 s for measuring AC current / voltage signals.
- The current output can drive up to 800 Ohms, with an adjustable response time of 0.0...60.0 seconds.
- Exceptional mA output load stability of < 0.001% of span / 100 Ohm.
- Meets the NAMUR NE21 recommendations, ensuring high accuracy in harsh EMC environments.
- Meets the NAMUR NE43 recommendations, allowing the control system to easily detect an input error.
- Each unit is tested to a high 2.3 kVAC, 3-port galvanic isolation level.
- Excellent signal to noise ratio of > 60 dB.

Mounting / installation / programming

- Very low power consumption means units can be mounted side by side without an air gap - even at 60°C ambient temperature.
- Configuration, monitoring, 2-point process calibration and more are accomplished using PR's 45xx detachable displays.
- All programming can be password-protected.

Applications

Input signals:

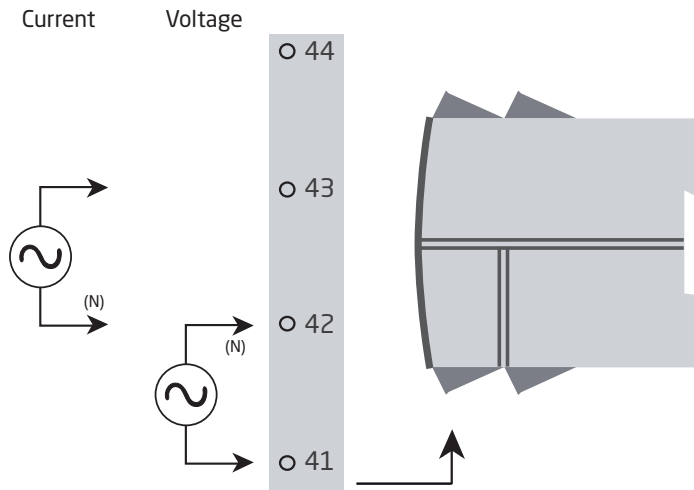

Output signals:

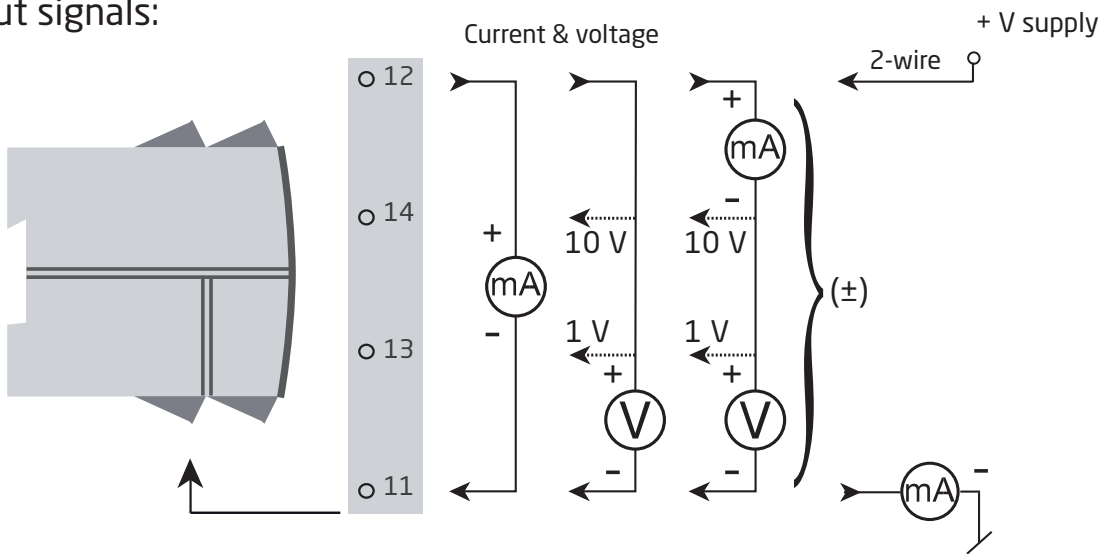

Power connection:

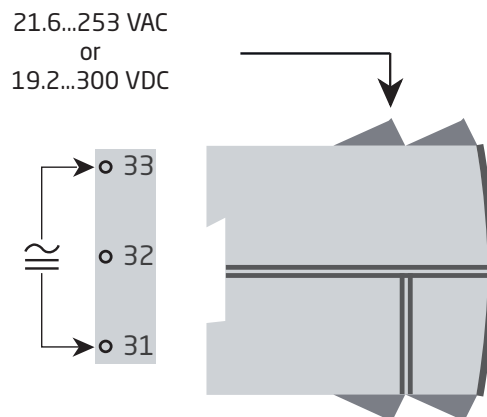

PR 45xx display / programming front



Functionality

The simple and easily understandable menu structure and the explanatory help texts guide you effortlessly and automatically through the configuration steps, thus making the product very easy to use. Functions and configuration options are described in the section "Configuration / operating the function keys".

Application

- Communications interface for modification of operational parameters in 4179.
- Can be moved from one 4179 device to another and download the configuration of the first unit to subsequent units.
- When mounted in the process, the display shows process values and device status.



Technical characteristics

- LCD display with 4 lines:
 - Line 1 (H=5.57 mm) shows the scaled process value - OK or error.
 - Line 2 (H=3.33 mm) shows the selected engineering unit.
 - Line 3 (H=3.33 mm) shows analog output or TAG no.
 - Line 4 shows status for communication and signal trending.
- Programming access can be blocked by assigning a password. The password is saved in the device in order to ensure a high degree of protection against unauthorized modifications to the configuration.

Mounting / demounting the PR 45xx

- 1: Insert the tabs of the PR 45xx into the holes at the top of the device.
- 2: Hinge the PR 45xx down until it snaps into place.

Demounting of the PR 45xx

- 3: Push the release button on the bottom of the PR 45xx and hinge the the PR 45xx out and up.
- 4: With the PR 45xx hinged up, remove from holes at the top of the device.

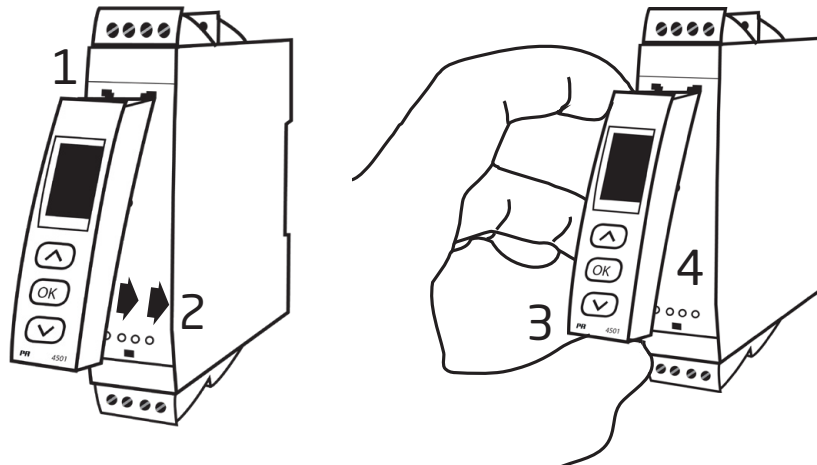

Order

4179 = Universal AC / DC transmitter

Accessories

4501 = Display / programming front

4511 = Modbus communication enabler

4512 = Bluetooth communication enabler

Electrical specifications

Environmental conditions:

Operating temperature	-20°C to +60°C
Storage temperature	-20°C to +85°C
Calibration temperature.	20...28°C
Relative humidity	< 95% RH (non-cond.)
Protection degree	IP20
Installation in pollution degree 2 & measurement / overvoltage category II.	

Mechanical specifications:

Dimensions (HxWxD)	109 x 23.5 x 104 mm
Dimensions (HxWxD) w/ 4501 / 451x	109 x 23.5 x 116 / 131 mm
Weight approx.	155 g
Weight incl. 4501 / 451x (approx.)	170 g / 185 g
DIN rail type.	DIN EN 60715 - 35 mm
Wire size.	0.13...2.08 mm ² / AWG 26...14 stranded wire
Screw terminal torque.	0.5 Nm

Common electrical specifications:

Supply voltage, universal.	21.6...253 VAC, 50...60 Hz or 19.2...300 VDC
Max. required power.	≤ 1.8 W nom.
Max. power dissipation	≤ 2.5 W
Isolation voltage - test	2.3 kVAC
Isolation voltage - working.	250 VAC (reinforced) / 500 VAC (basic)
Programming	PR 45xx
Signal dynamics, input / output	20 bit / 18 bit
Signal / noise ratio.	> 60 dB
Response time (0...90%, 100...10%)	< 0.75 s
Output referred common mode rejection ratio	0.02 ppm / VHz

Accuracy, the greater of general and basic values:

General values		
Input type	Absolute accuracy	Temperature coefficient
All	$\leq \pm 0.3\%$ of span*	$\leq \pm 0.01\%$ of span* / °C

Basic values		
Input type	Basic accuracy	Temperature coefficient
Current	1.5 mA	50 μ A/ °C
Voltage	1.5 mVAC	50 μ VAC /°C

EMC - immunity influence.	< $\pm 0.5\%$ of span*
Extended EMC immunity: NAMUR NE 21, A criterion, burst	< $\pm 1\%$ of span*

of span = of selected standard range

* For custom signals, general accuracy and EMC specifications are 0.3% of full scale

Input specifications:

Current input:

Signal range.	0...5 AAC / 40...400 Hz
Maximum input limit.	6.00 AAC @ 40°C
Programmable measurement ranges	0...0.5, 0...1, 0...2.5 & 0...5 AAC
Custom configurable signal range.	0...5 AAC / 40...400 Hz
Min. span	0.5 AAC
Input resistance	Nom. < 0.07 Ω

Voltage input:

Signal range.	0...300 VAC / 40...400 Hz
Programmable measurement ranges	0...0.5, 0...1, 0...2.83, 0...5, 0...120, 0...230 & 0...300 VAC
Custom configurable signal range.	0...300 VAC / 40...400 Hz
Min. span	0.5 VAC
Input resistance	Nom. 3 M Ω 100 pF

Configurable input limits:

Configurable input limits, low:

VOLT	0 VAC to 'Minimum selected input'
CURR.	0 AAC to 'Minimum selected input'

Configurable input limits, high:

VOLT	'Maximum selected input' to 300 VAC
CURR.	'Maximum selected input' to 5 AAC

Input limit low/high, error indication levels:

UP	See table on page 14
DOWN	See table on page 14
ZERO.	See table on page 14
NONE	See table on page 14
Hysteresis.	0.5% of 'Max. output'
Error detection release delay	< 2.5 s

Current output specifications:

Active unipolar and bipolar mA:

Programmable ranges	0...20, 4...20, S4...20, ± 10 and ± 20 mA
	Direct or Inverted action
V-curve function, 100-0-100%	20-0-20 mA
Load.	$\leq 800 \Omega$

Passive 2-wire mA:

Programmable ranges	0...20 and 4...20 mA
	Direct or Inverted action
V-curve function, 100-0-100%	20-0-20 mA
External 2-wire loop supply	3.5...30 V

Input overcurrent

For overcurrent situations, e.g. high inrush current, the 4179 is designed to handle maximum overcurrent for a period of time as illustrated below.

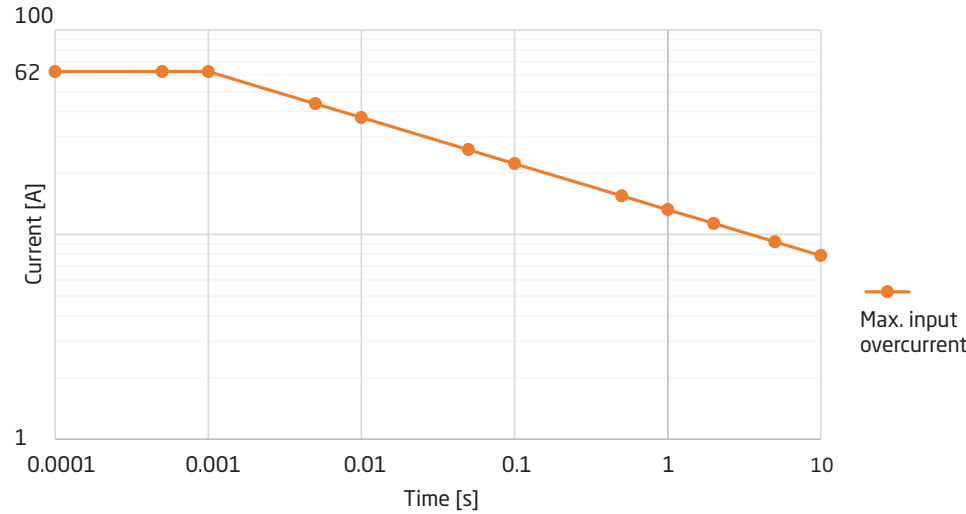

Common specifications current output:

All standard and custom ranges can be selected as Direct or Inverted action.
V-function can be selected for fixed output ranges starting at zero.

Signal range.	0...23 mA (unipolar) / -23...+23 mA (bipolar)
Current limit.	≤ 28 mA (unipolar) / ±28 mA (bipolar)
Load stability	≤ 0.001% of span / 100 Ω
Response time, programmable.	0.0...60.0 s
Output limitation at outside range	See table on page 14

Voltage output specifications:

All standard and custom ranges can be selected as Direct or Inverted action.
V-function can be selected for fixed output ranges starting at zero.

Programmable ranges	0/0.2...1, 0/1...5, 0/2...10, ±1, ±5 and ±10 V
	Direct or Inverted action
V-curve function, 100-0-100%	1-0-1 V, 5-0-5 V and 10-0-10 V
Load, min	> 500 kΩ
Response time, programmable.	0.0...60.0 s
Output limitation at outside range	See table on page 14

Observed authority requirements:

EMC.	2014/30/EU
LVD	2014/35/EU
RoHS.	2011/65/EU

Approvals:

c UL us, Standard for Safety	UL 508 / C22.2 No. 14
--	-----------------------

Functional Safety:

Hardware assessed for use in SIL applications
FMEDA report - www.prelectronics.com

Configurable input error indication and input limits

Configurable input error detection

To increase system safety and integrity, users can program a high and low input error detection level. Input signals outside the selected error indication levels will cause the output of the device to go to the programmed error state. The error is indicated in display line 1 as IN.ER and at the same time the backlight flashes.

The two configurable input error detection levels can be set and enabled individually, just as it is possible to individually set the output error indication for each of the two detection levels. This allows users to differentiate process faults, broken input wires, etc.

Available output error states for each of the two detection levels are: UP, DOWN, ZERO and NONE.

Output error indication uses the error states defined by NAMUR NE43 for 4...20 mA output span, and for all other output spans equivalent output error indications are used (see table on page 14).

Example - 4..20 mA output span and both high and low configurable input error limit enabled with output error indication set to ZERO:

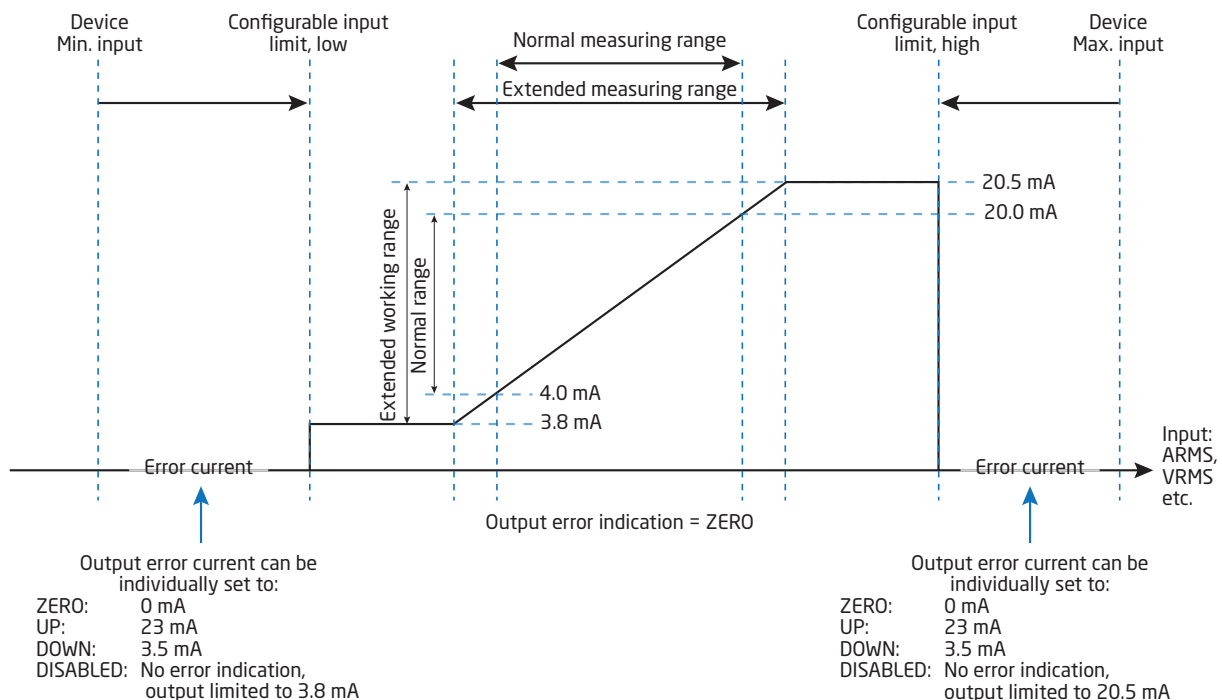

Example - input limits disabled:

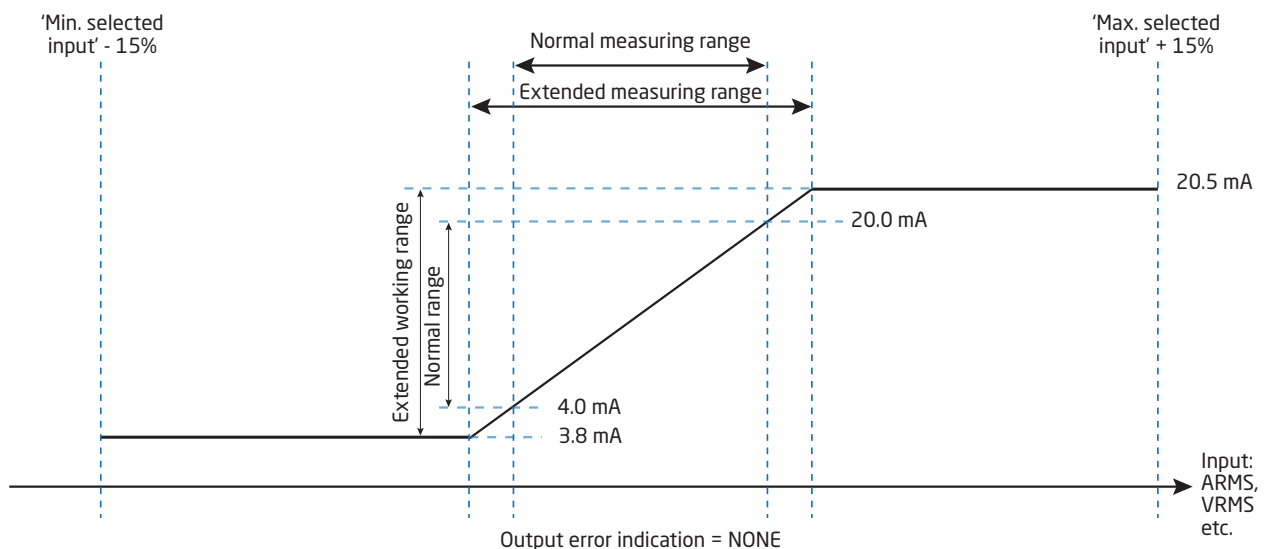

Output limits and error indications - current output:

	Input limit check disabled		Input limit check Low and / or High enabled					
Output span	Output limit low	Output limit high	Output limit low	Output limit high	Output error indication, UP	Output error indication, DOWN	Output error indication, ZERO	Output error indication, NONE
4...20 mA	0 mA	23 mA	3.8 mA	20.5 mA	23 mA	3.5 mA	0 mA	No error indication
0...20 mA	0 mA	23 mA	0 mA	20.5 mA	23 mA	0 mA	0 mA	No error indication
±10 mA	-11.5 mA	11.5 mA	-10.25 mA	10.25 mA	11.5 mA	-11.5 mA	0 mA	No error indication
±20 mA	-23 mA	23 mA	-20.5 mA	20.5 mA	23 mA	-23 mA	0 mA	No error indication

Output limits and error indications - voltage output:

	Input limit check disabled		Input limit check Low and / or High enabled					
Output span	Output limit low	Output limit high	Output limit low	Output limit high	Output error indication, UP	Output error indication, DOWN	Output error indication, ZERO	Output error indication, NONE
0...1 V	0 V	1.15 V	0 V	1.025 V	1.15 V	0 V	0 V	No error indication
0.2...1 V	0 V	1.15 V	0.195 V	1.025 V	1.15 V	0.175 V	0 V	No error indication
0...5 V	0 V	5.75 V	0 V	5.125 V	5.75 V	0 V	0 V	No error indication
1...5 V	0 V	5.75 V	0.975 V	5.125 V	5.75 V	0.875 V	0 V	No error indication
0...10 V	0 V	11.5 V	0 V	10.25 V	11.5 V	0 V	0 V	No error indication
2...10 V	0 V	11.5 V	1.95 V	10.25 V	11.5 V	1.75 V	0 V	No error indication
±1 V	-1.15 V	1.15 V	-1.025 V	1.025 V	1.15 V	-1.15 V	0 V	No error indication
±5 V	-5.75 V	5.75 V	-5.125 V	5.125 V	5.75 V	-5.75 V	0 V	No error indication
±10 V	-11.5 V	11.5 V	-10.25 V	10.25 V	11.5 V	-11.5 V	0 V	No error indication

45xx display readout of input error detection and signal "outside range"

Configurable input error detection - readout (IN.ER):			
Input	Range	Readout	Limit
CURR	All	IN.ER	See table on page 14
VOLT	All	IN.ER	See table on page 14

Display readout below min. / above max. (-1999, 9999):			
Input	Range	Readout	Limit
All	All	-1999	Display readout <-1999
		9999	Display readout >9999

Readout at hardware error		
Error search	Readout	Cause
Check measurement of analog output	AO.ER	No load on the current output (only S4...20 mA)*
Communications test between 45xx and 4179	NO.CO	Connection error
Configuration error	CO.ER	Default configuration is loaded
Configuration error	CO.ER	Invalid configuration**
Check that saved configuration in 45xx matches device	TY.ER	Invalid type or rev. no.
Hardware error	RA.ER	RAM error*
Hardware error	AD.ER	A/D converter error*
Hardware error	AO.SU	Analog output supply error*
Hardware error	EF.ER	External flash error*
Hardware error	IF.ER	Internal flash error*

!	All error indications in the display flash once per second. The help text explains the error. If the error is an input loop error, the display backlight flashes as well - this is acknowledged (stopped) by pushing the  button.
*	Error is acknowledged by either stepping through the basic setup, or by resetting the device power. Some types of errors can only be acknowledged by resetting the device power.
**	Error is acknowledged by stepping through the basic setup.

Connections

Supply

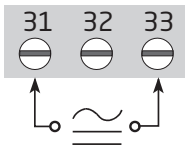

Inputs:

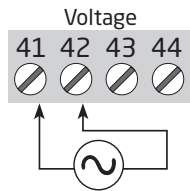
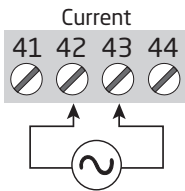

Outputs:

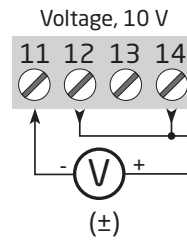
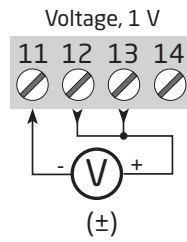
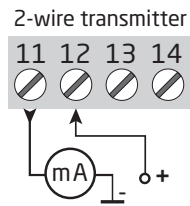
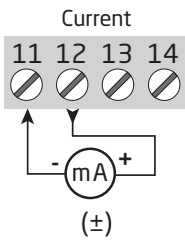

Block diagram

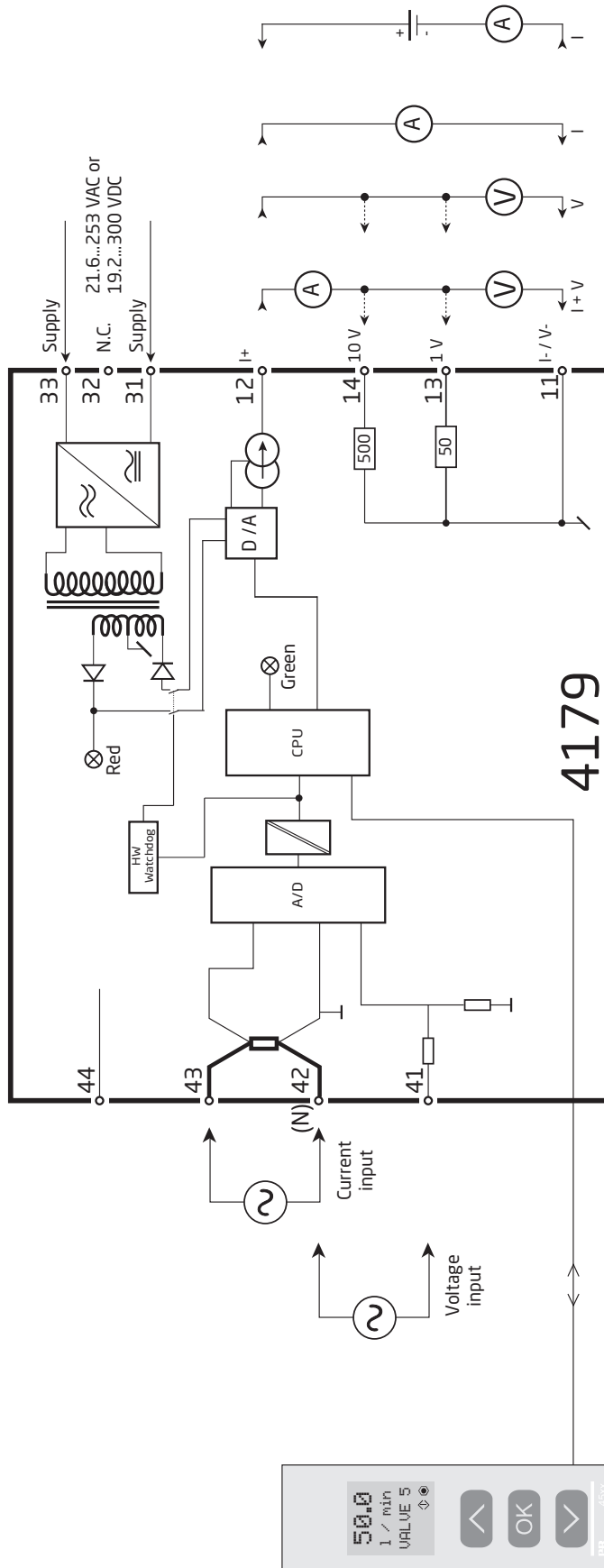

Configuration / operating the function keys

Documentation for routing diagram.

In general

When configuring the 4179, you will be guided through all parameters and you can choose the settings which fit the application. For each menu there is a scrolling help text which is automatically shown in line 3 on the display.

Configuration is carried out by use of the 3 function keys:

- ⏪ will increase the numerical value or choose the next parameter
- ⏩ will decrease the numerical value or choose the previous parameter
- ⏹ will save the chosen value and proceed to the next menu

When configuration is completed, the display will return to the default state 1.0. Pressing and holding ⏹ will return to the previous menu or return to the default state (1.0) without saving the changed values or parameters.

If no key is activated for 1 minute, the display will return to the default state (1.0) without saving the changed values or parameters.

Further explanations

Password protection: Programming access can be blocked by assigning a password. The password is saved in the device in order to ensure a high degree of protection against unauthorised modifications to the configuration.

If the configured password is not known, please contact PR electronics support - www.prelectronics.com/contact.

Signal and sensor error indication via display front 45xx

Error indication is displayed in line 1 as text and at the same time the backlight flashes. A flashing bullet in line 4 is indicating correct functioning of 45xx.

Signal and sensor error indication without display front

Status of the unit can also be read from the red/green LED in the front of the device.

Green flashing LED 13 Hz indicates normal operation.

Green flashing LED 1 Hz indicates loop error.

Steady green LED indicates internal error.

Steady red LED indicates fatal error.

Advanced functions

The unit gives access to a number of advanced functions which can be reached by answering "Yes" to the point "ADV.SET".

Memory (MEM): In the memory menu you can save the configuration of the device in the 45xx, and then move the 45xx onto another device of the same type and download the configuration in the new device.

Display setup (DISP): Here you can adjust the brightness contrast and the backlight. Setup of TAG numbers with 6 alphanumeric. Selection of functional readout in line 3 of the display - choose between readout of analogue output or tag no.

Two-point process calibration (CAL): The device can be process-calibrated in 2 points to fit a given input signal. A low input signal (not necessarily 0%) is applied and the actual value is entered via 45xx Then a high signal (not necessarily 100%) is applied and the actual value is entered via 45xx. If you accept to use the calibration, the device will work according to this new adjustment. If you later reject this menu point or choose another type of input signal the device will return to factory calibration.

Process simulation function (SIM): In the menu point "EN.SIM" it is possible to simulate an input signal by means of the arrow keys and thus control the output signal up or down. You must exit the menu by pressing ⏹ (no time-out). The simulation function exits automatically, if the 45xx is detached.

Password (PASS): Here you can choose a password between 0000 and 9999 in order to protect the unit against unauthorised modifications to the configuration. The unit is delivered default without password.

Language (LANG): In the menu "LANG" you can choose between 7 different language versions of help texts that will appear in the menu. You can choose between UK, DE, FR, IT, ES, SE and DK.

Output function (OFUN): Here the output characteristics can be set to either Direct (DIR) or Inverted (INV) function. Output type and range are set in the normal programming menu. If the selected output range is starting at zero, V-curved output function (VFUN) can also be selected. The output characteristics will then be 100-0-100% on the basis of a linear 0-100% input signal.

Auto diagnostics

The device performs an advanced auto diagnosis of the internal circuits - check tables on page 15.

Routing diagram

If no key is activated for 1 minute, the display will return to the default state 1.0 without saving configuration changes.

- ⏴ Increase value / choose next parameter
- ⏵ Decrease value / choose previous parameter
- ⏹ Save the chosen value and proceed to the next menu
- ⏪ Hold ⏹ Back to previous menu / return to menu 1.0 without saving.

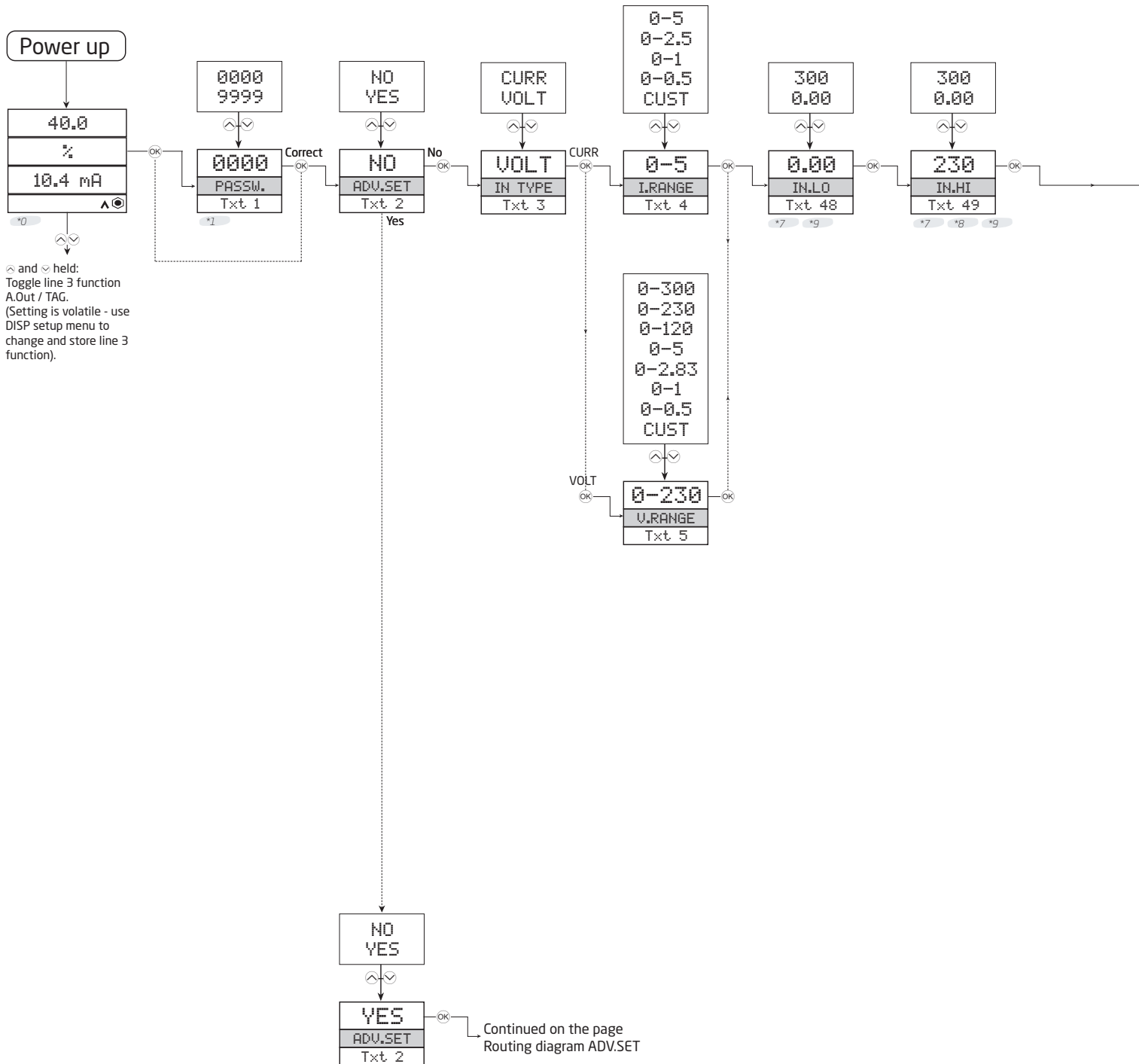

*0 Default state.
Line 1 shows the scaled process value - OK or error.
Line 2 shows the selected engineering unit.
Line 3 shows analogue output or TAG no.
Line 4 shows status for communication and signal trending.

*1 Only displayed if password is enabled.

*7 Only displayed if CUST is selected!
This menu will change range automatically.

*8 Value will be forced to be greater than xx.LO.

*9 Maximum and minimum value selectable from menu must be based on input type
VOLT: Min: 0.000 Max: 300
CURR: Min: 0.000 Max: 5.00

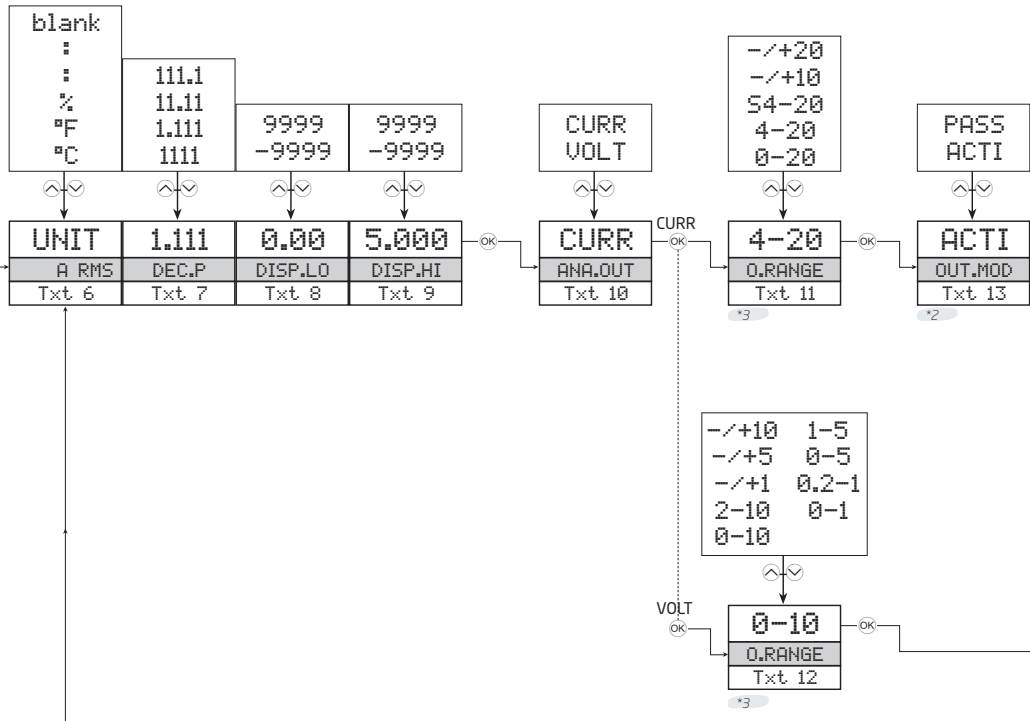

Selectable UNITS:

°C	hPa	l	min	t
°F	Hz	l/h	mm	t/h
%	in	l/min	mm/s	uA
A	in/h	l/s	mol	um
bar	in/min	m	Mpa	uS
cm	in/s	m/h	mV	V
ft	ips	m/min	MW	W
ft/h	K	m/s	MWh	Wh
ft/min	kA	m/s ²	N	yd
ft/s	k9	m ³	Ohm	URMS
g	kJ	m ³ /h	Pa	ARMS
gal/h	kPa	m ³ /min	PH	[blank]
gal/min	kV	mA	rPM	
GW	kW	mbar	s	
hp	kWh	mils	S	

*2 Menu not displayed if a Bipolar Output Range is selected.

*3 Direct or Inverted output characteristics must be set in the ADV setting OFUN menu. Only ranges starting at zero are available for OFUN = V.FUNC - refer to *6.

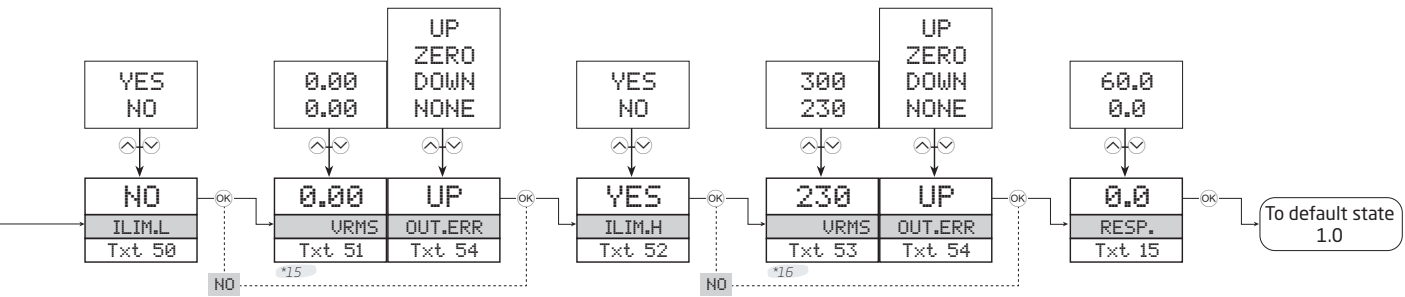

*15 Limits are dependent on input type and the selected input range:
 High limit: 'Minimum input'
 Low limit, CURR: 0 AAC
 Low limit, VOLT: 0 VAC

*16 Limits are dependent on input type and the selected input range:
 Low limit: 'Maximum input'
 High limit, CURR: 5.00 AAC
 High limit, VOLT: 300 VAC

Routing diagram, advanced settings (ADV.SET)

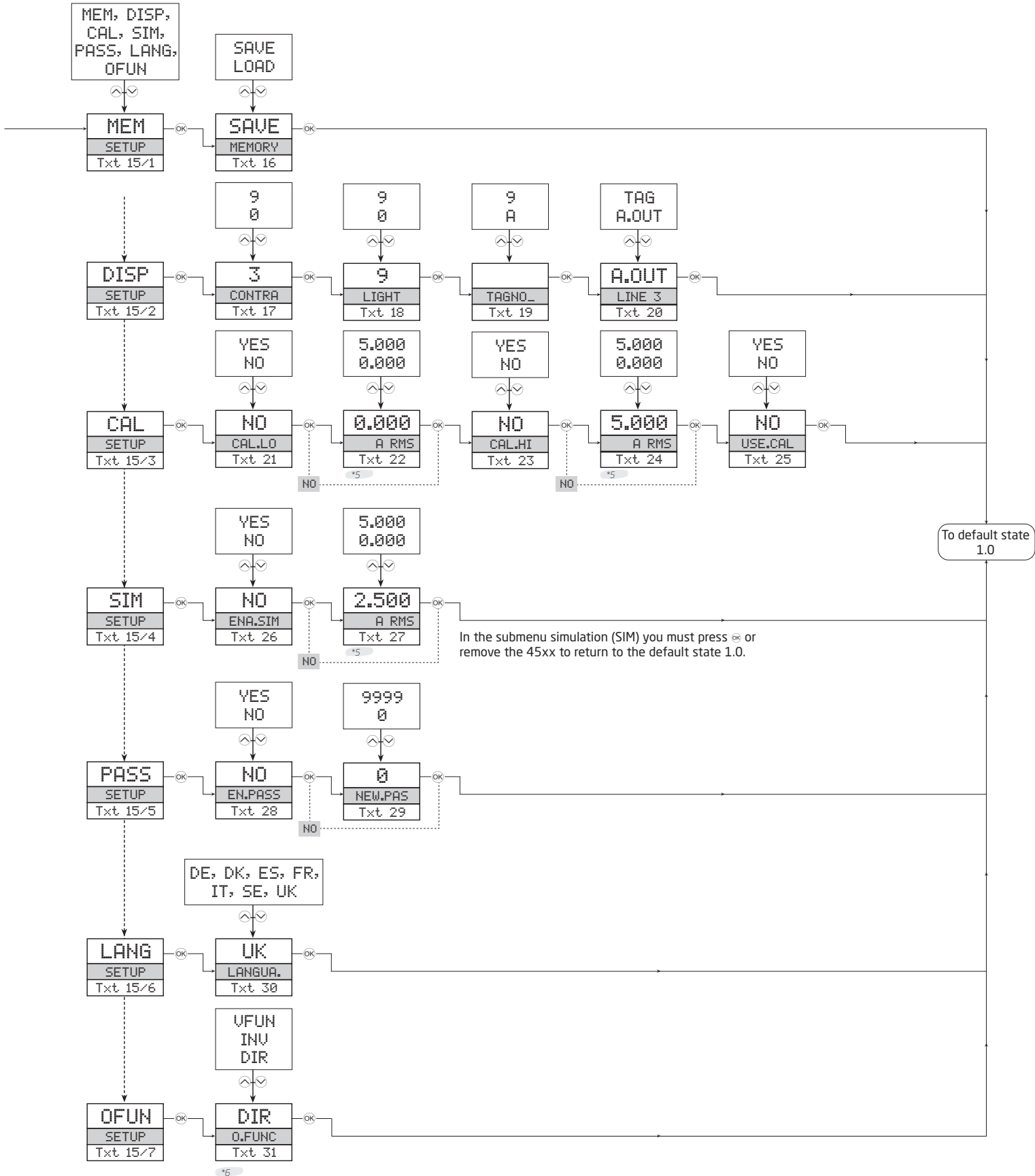

*5 Selectable range as defined by DEC.P, DISP.LO and DISP.HI.

*6 VFUN (V-shaped output function) is only available when a fixed output range starting at zero is selected. DIR (direct) and INV (inverted) output can be combined with all fixed or CUST output ranges.

Help text overview

- [1] Set correct password
- [2] Enter advanced setup menu?
- [3] Select current input
Select voltage input
- [4] Select 0...5 A input range
Select 0...2.5 A input range
Select 0...1 A input range
Select 0...0.5 A input range
Select custom current input range
- [5] Select 0...230 V input range
Select 0...120 V input range
Select 0...2.83 V input range
Select 0...1 V input range
Select 0...0.5 V input range
Select custom voltage input range
- [6] Select display unit
- [7] Select decimal point position
- [8] Set display range low
- [9] Set display range high
- [10] Select current as analog output type
Select voltage as analog output type
- [11] Select 0...20 mA output range
Select 4...20 mA output range
Select 4...20 mA with safety readback
Select -10...10 mA output range
Select -20...20 mA output range
- [12] Select 0.0...1 V output range
Select 0.2...1 V output range
Select 0...5V output range
Select 1...5V output range
Select 0...10V output range
Select 2...10V output range
Select -1...1 V output range
Select -5...5 V output range
Select -10...10 V output range
- [13] Select active output mode
Select passive output mode
- [14] Set Analog output response time in seconds
- [15] Select Analog Output Function
Enter Language setup
Enter Password setup
Enter Simulation mode
Perform Process calibration
Enter Display setup
Perform Memory operations
- [16] Load saved configuration into module
Save configuration in display front
- [17] Adjust LCD contrast
- [18] Adjust LCD backlight
- [19] Write a 6-character device TAG
- [20] Analog output value is shown in display line 3
Device TAG is shown in display line 3
- [21] Calibrate Input low to process value?
- [22] Set value for low calibration point
- [23] Calibrate Input high to process value?
- [24] Set value for high calibration point
- [25] Use process calibration values?
- [26] Enable simulation mode?
- [27] Set the input simulation value
- [28] Enable password protection?
- [29] Set new password
- [30] Select language
- [31] Select direct output mode
Select inverted output mode
Select V-function output mode
- [32] Display underrange
- [33] Display overrange
- [34] Input underrange
- [35] Input overrange
- [36] Analog output supply error
- [37] Analog output error - check output connections and reset power
- [38] Configuration error - default configuration is loaded
- [39] RAM memory error
- [40] Invalid configuration
- [41] A/D converter error
- [42] No communication
- [44] Input range limit error - Input outside configurable input range limit
- [45] Invalid configuration type or version
- [46] External flash error
- [47] Internal flash error
- [48] Set input range low
- [49] Set input range high
- [50] Enable configurable input limit, low
- [51] Set configurable input limit, low
- [52] Enable configurable input limit, high
- [53] Set configurable input limit, high
- [54] Select downscale at error
Select zero output at error
Select upscale at error
Select no error action - output undefined at error

Document history

The following list provides notes concerning revisions of this document.

Rev. ID	Date	Notes
100	1740	Initial release of the product
101	1914	SIL HW assessment added

We are near you, *all over the world*

Our trusted red boxes are supported wherever you are

All our devices are backed by expert service and a 5-year warranty. With each product you purchase, you receive personal technical support and guidance, day-to-day delivery, repair without charge within the warranty period and easily accessible documentation.

We are headquartered in Denmark, and have offices and authorized partners the world over. We are a local

business with a global reach. This means that we are always nearby and know your local markets well. We are committed to your satisfaction and provide **PERFORMANCE MADE SMARTER** all around the world.

For more information on our warranty program, or to meet with a sales representative in your region, visit prelectronics.com.

Benefit today from *PERFORMANCE MADE SMARTER*

PR electronics is the leading technology company specialized in making industrial process control safer, more reliable and more efficient. Since 1974, we have been dedicated to perfecting our core competence of innovating high precision technology with low power consumption. This dedication continues to set new standards for products communicating, monitoring and connecting our customers' process measurement points to their process control systems.

Our innovative, patented technologies are derived from our extensive R&D facilities and from having a great understanding of our customers' needs and processes. We are guided by principles of simplicity, focus, courage and excellence, enabling some of the world's greatest companies to achieve PERFORMANCE MADE SMARTER.